

**LONG T-WALL
PLAN VIEW**

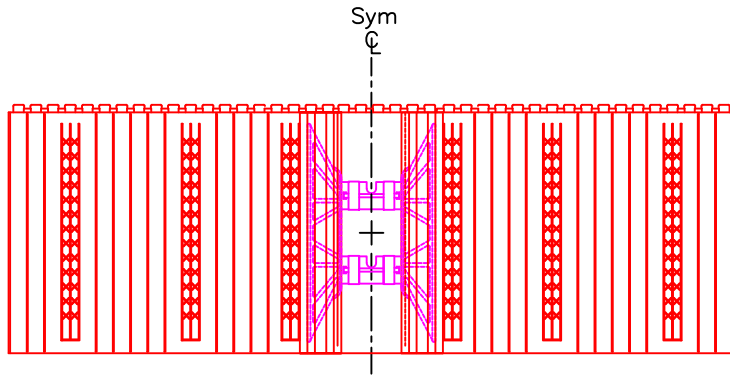

**LONG T-WALL
SIDE ELEVATION**

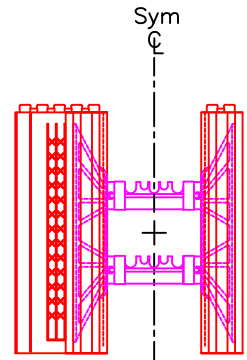

**LONG T-WALL
END VIEW**

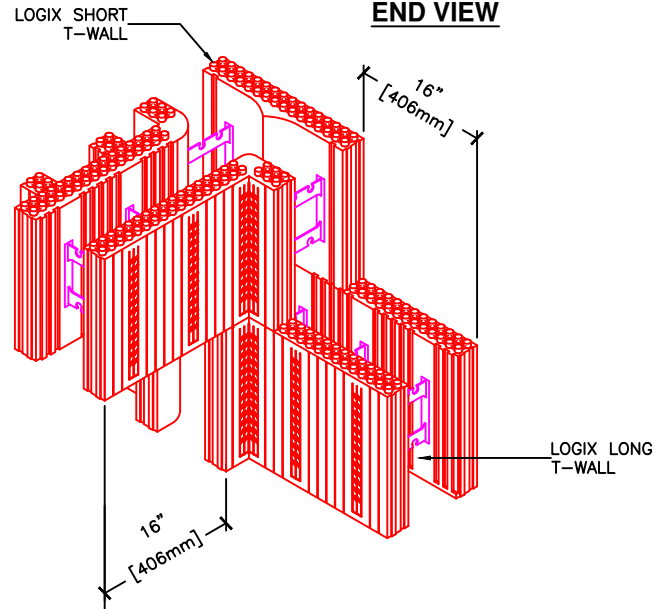

T-WALL SIZES								
	6 1/4" to 4" (159mm to 102mm)	6 1/4" to 6 1/4" (159mm to 159mm)	8" to 4" (203mm to 102mm)	8" to 6 1/4" (203mm to 159mm)	10" to 4" (254mm to 102mm)*	10" to 6 1/4" (254mm to 159mm)*	12" to 4" (305mm to 102mm)*	12" to 6 1/4" (305mm to 159mm)*
A	48" (1219mm)	50.25" (1276mm)	48" (1219mm)	50.25" (1276mm)	48" (1219mm)	50.25" (1276mm)	48" (1219mm)	50.25" (1276mm)
B	5.375" (137mm)	6.5" (165mm)	5.375" (137mm)	6.5" (165mm)	5.375" (137mm)	6.5" (165mm)	5.375" (137mm)	6.5" (165mm)
C	11.75" (298mm)	11.75" (298mm)	13.5" (343mm)	13.5" (343mm)	15.5" (394mm)	15.5" (394mm)	17.5" (445mm)	17.5" (445mm)
D	6.25" (159mm)	6.25" (159mm)	8" (203mm)	8" (203mm)	10" (254mm)	10" (254mm)	12" (305mm)	12" (305mm)
E	4" (102mm)	6.25" (159mm)	4" (102mm)	6.25" (159mm)	4" (102mm)	6.25" (159mm)	4" (102mm)	6.25" (159mm)
F	9.5" (241mm)	11.75" (298mm)	9.5" (241mm)	11.75" (298mm)	9.5" (241mm)	11.75" (298mm)	9.5" (241mm)	11.75" (298mm)

*Assembled without diagonal tie



The drawing represented herein is to be used as a reference guide only; the user shall check to ensure the drawing meets local building codes and construction practices by consulting local building officials and professionals, including any additional requirements. Logix reserves the right to make changes to the drawing without notice and assumes no liability in connection with the use of the drawing including modification, copying or distribution.

Drawing:
5.1.2.5A

Date:
Nov 12/14

1/2

Title:

LOGIX T-WALL (LONG)

		T-WALL SIZES							
		6¼" to 4" (159mm to 102mm)	6¼" to 6¼" (159mm to 159mm)	8" to 4" (203mm to 102mm)	8" to 6¼" (203mm to 159mm)	10" to 4" (254mm to 102mm)*	10" to 6¼" (254mm to 159mm)*	12" to 4" (305mm to 102mm)*	12" to 6¼" (305mm to 159mm)*
A		16" (406mm)	18.25" (464mm)	16" (406mm)	18.25" (464mm)	16" (406mm)	18.25" (464mm)	16" (406mm)	18.25" (464mm)
B		5.375" (137mm)	6.5" (165mm)	5.375" (137mm)	6.5" (165mm)	5.375" (137mm)	6.5" (165mm)	5.375" (137mm)	6.5" (165mm)
C		11.75" (298mm)	11.75" (298mm)	13.5" (343mm)	13.5" (343mm)	15.5" (394mm)	15.5" (394mm)	17.5" (445mm)	17.5" (445mm)
D		6.25" (159mm)	6.25" (159mm)	8" (203mm)	8" (203mm)	10" (254mm)	10" (254mm)	12" (305mm)	12" (305mm)
E		4" (102mm)	6.25" (159mm)	4" (102mm)	6.25" (159mm)	4" (102mm)	6.25" (159mm)	4" (102mm)	6.25" (159mm)
F		9.5" (241mm)	11.75" (298mm)	9.5" (241mm)	11.75" (298mm)	9.5" (241mm)	11.75" (298mm)	9.5" (241mm)	11.75" (298mm)

*Assembled without diagonal tie

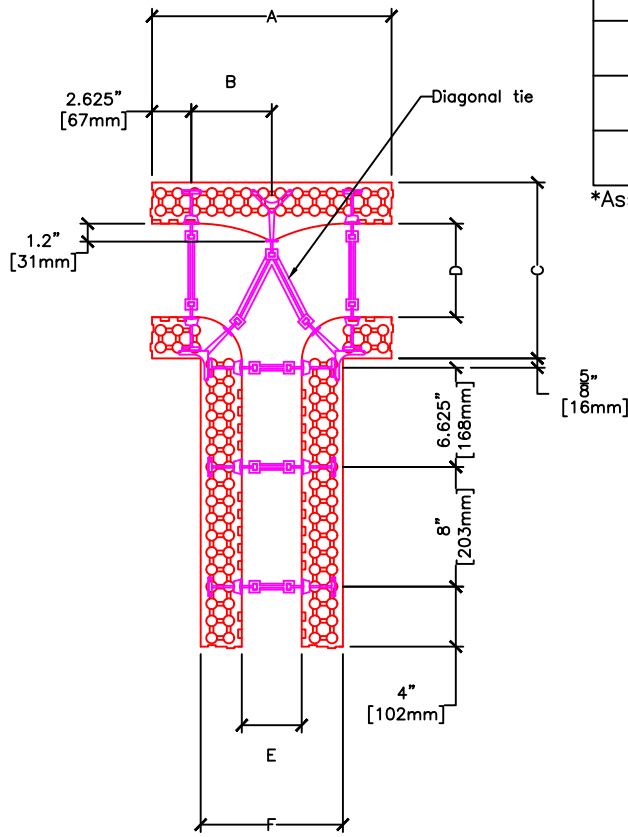

**SHORT T-WALL
PLAN VIEW**

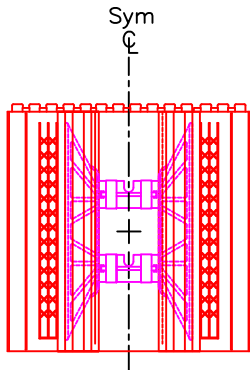
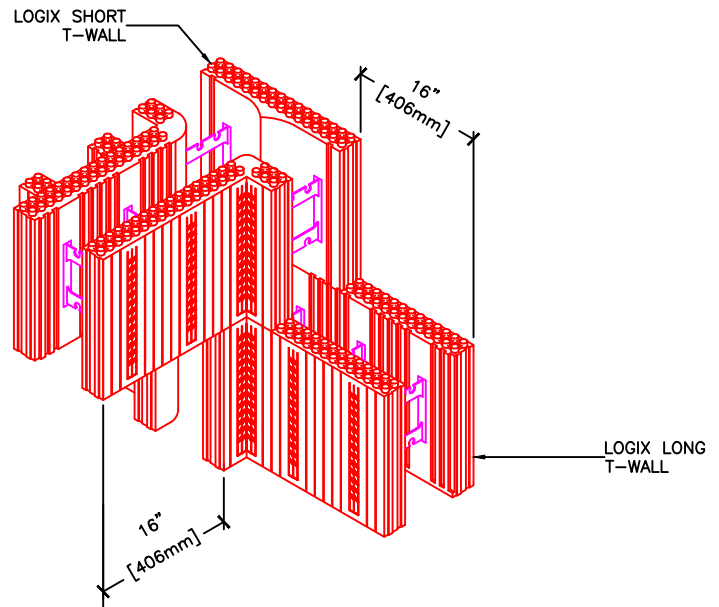

**LONG T-WALL
SIDE ELEVATION**

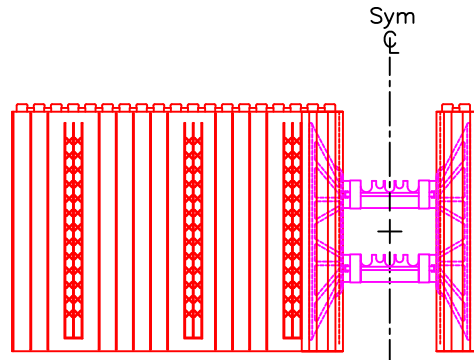

**LONG T-WALL
END VIEW**