

**PLAN VIEW**

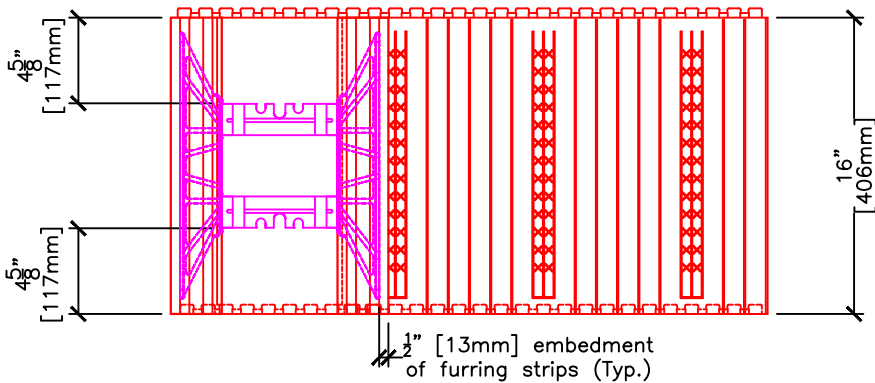

**SIDE ELEVATION**

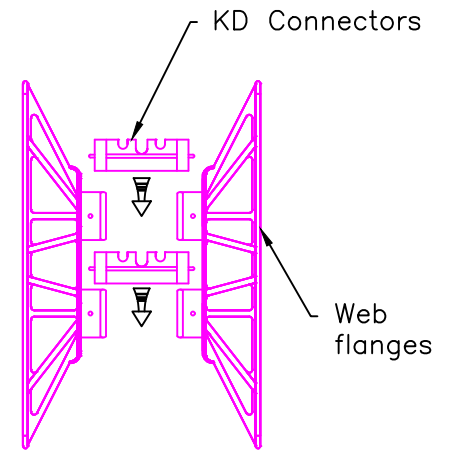

**WEB COMPONENTS (NTS)**

	FORM SIZES, in (mm)			
	4 (102)	6.25 (159)	8 (203)	10 (254)
Dimension A, in (mm)	N/A	6.25 (159)	8 (203)	10 (254)
Dimension B, in (mm)	N/A	11.75 (298)	13.5 (343)	15.5 (394)
Dimension C, in (mm)	N/A	3.375 (86)	2.25 (57)	2.125 (54)
Dimension D, in (mm)	N/A	7.67 (195)	6.125 (156)	5.875 (149)
Dimension E, in (mm)	N/A	32.125 (816)	32.125 (816)	34.5 (876)
Dimension F, in (mm)	N/A	16.125 (410)	16.125 (410)	18.5 (470)
Conc. Vol. (y <sup>3</sup> )	N/A	0.078	0.095	0.128
Conc. Vol. (ft <sup>3</sup> )	N/A	2.096	2.558	3.456
Conc. Vol. (m <sup>3</sup> )	N/A	0.059	0.072	0.098
Outside Corner Wall Area (ft <sup>2</sup> )	N/A	5.361	5.361	5.889
Inside Corner Wall Area (ft <sup>2</sup> )	N/A	2.750	2.361	2.444

**NOTES:**

1. Drawings showing rebar slot locations will be available upon request.
2. For 12" Right Hand LOGIX KD Corner Form see Pg 3/4 or 4/4.
3. Concrete core thickness wider than 12" (305mm) are available using LOGIX Xtenders (See Logix Xtender Product drawing).
4. 6 1/4" [159mm] LOGIX Corner Form shown.

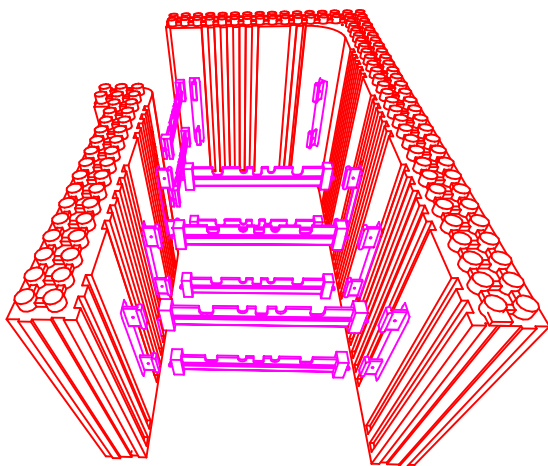

www.logixcf.com  
1-866-944-0153

The drawing represented herein is to be used as a reference guide only; the user shall check to ensure the drawing meets local building codes and construction practices, including any additional requirements. Logix reserves the right to make changes to the drawing without notice and assumes no liability in connection with the use of the drawing including modification, copying or distribution.

Drawing:  
5.1.2.1A

Date:  
Dec 24/16

Pg:  
1/2

Title:

RIGHT HAND LOGIX KD CORNER FORM

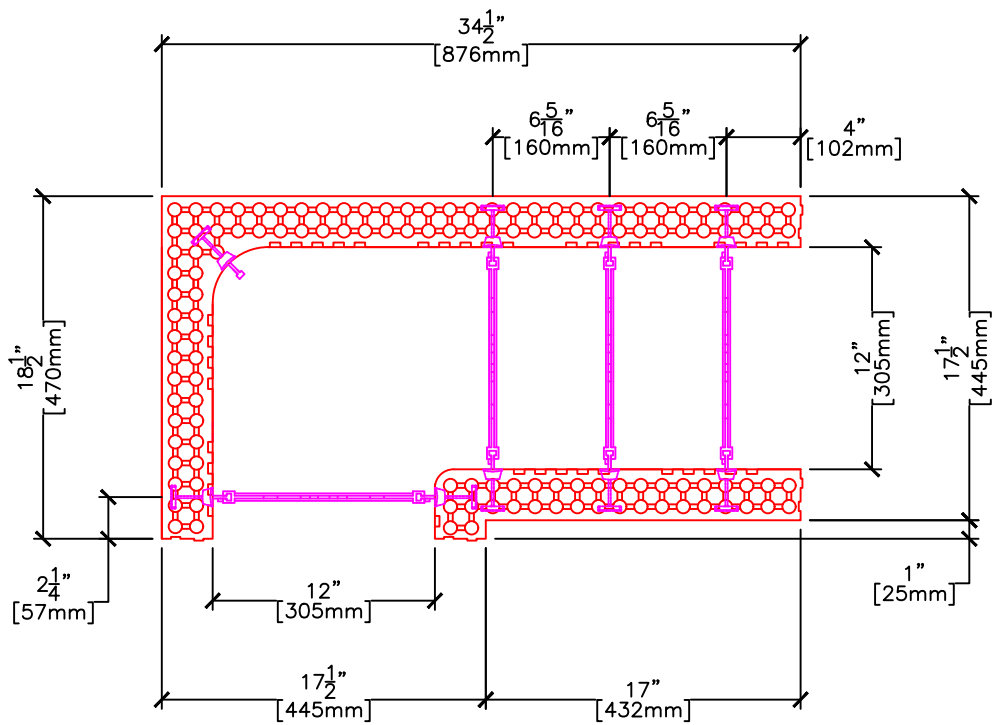

**PLAN VIEW**

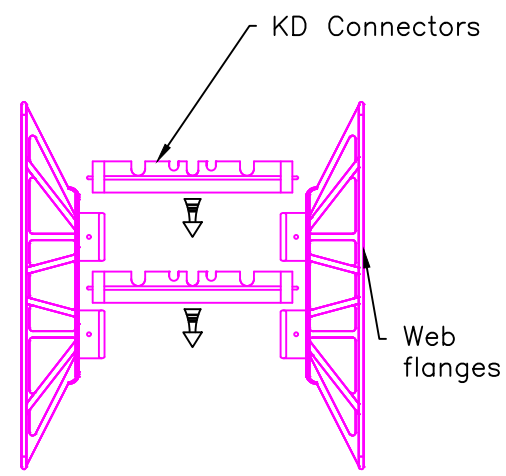

**WEB COMPONENTS (NTS)**

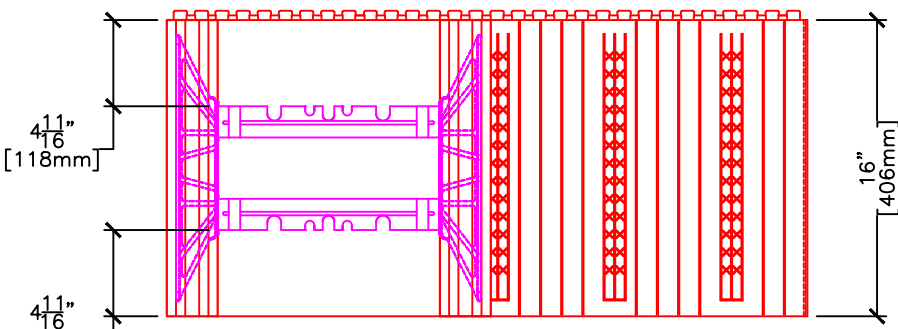

**SIDE ELEVATION**

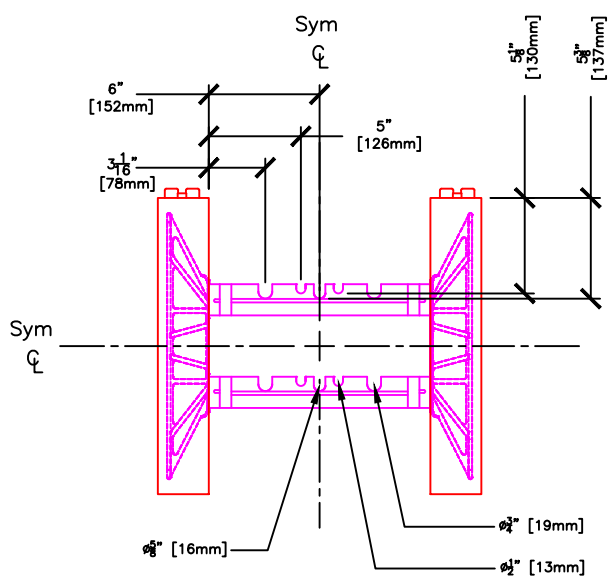

**REBAR SLOT LOCATIONS**

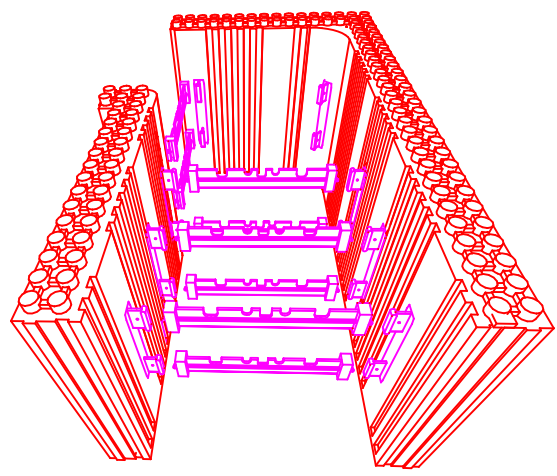

Conc. Vol. (y <sup>3</sup> )	0.146
Conc. Vol. (ft <sup>3</sup> )	3.929
Conc. Vol. (m <sup>3</sup> )	0.111
Outside Corner Wall Area (ft <sup>2</sup> )	5.889
Inside Corner Wall Area (ft <sup>2</sup> )	2.000

**NOTES:**

1. Drawings showing rebar slot locations will be available upon request.
2. Concrete core thickness wider than 12" (305mm) are available using LOGIX Xtenders (See Logix Xtender Product drawing).



The drawing represented herein is to be used as a reference guide only; the user shall check to ensure the drawing meets local building codes and construction practices, including any additional requirements. Logix reserves the right to make changes to the drawing without notice and assumes no liability in connection with the use of the drawing including modification, copying or distribution.

Drawing: 5.1.2.1B	Date: Dec 24/16	Pg: 2/2
Title: RIGHT HAND KNOCKDOWN 12" CORNER FORM		