

ICFVL
ledger connection

LUS
Hanger

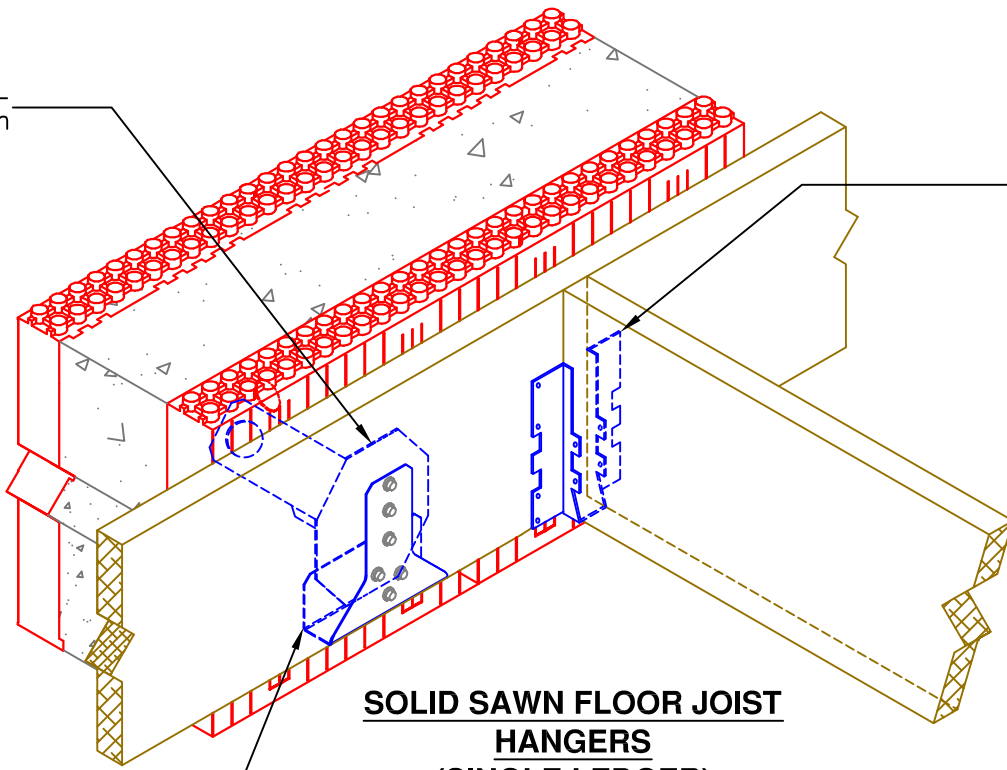

**SOLID SAWN FLOOR JOIST
HANGERS
(SINGLE LEDGER)**

ICFVL-W for solid sawn
lumber or ICFVL-CW for LVL

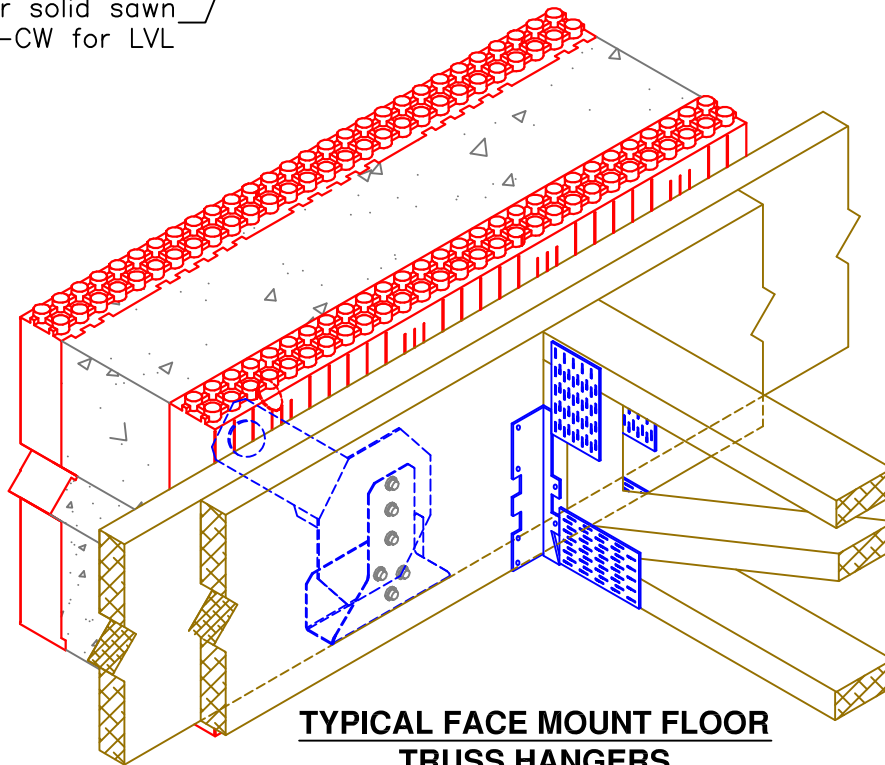

**TYPICAL FACE MOUNT FLOOR
TRUSS HANGERS
(DOUBLE LEDGER)**

NOTES:

1. For more information see Section 2 of the LOGIX Product Manual or visit www.strongtie.com.
2. Use extra caution when installing Simpson ICF Ledger Connection systems on both sides of a wall. Consult your local Simpson Strongtie rep or call Simpson Strongtie at (800) 999-5099 prior to installation.
3. Attachment of second ledger to be designed by others.



The drawing represented herein is to be used as a reference guide only; the user shall check to ensure the drawing meets local building codes and construction practices by consulting local building officials and professionals, including any additional requirements. Logix reserves the right to make changes to the drawing without notice and assumes no liability in connection with the use of the drawing including modification, copying or distribution.

Drawing:
5.8.9

Date:
Jul 30/13

Title:
SIMPSON STRONG TIE – ICF LEDGER
CONNECTION SYSTEM