

FORM SUPPORT - EXTERIOR SIDE

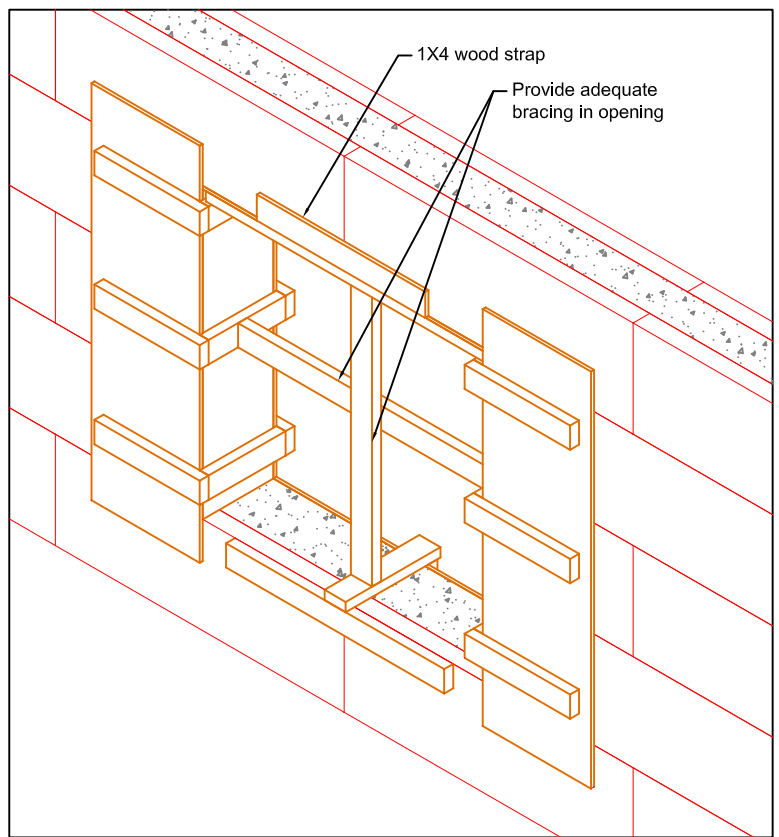

FORM SUPPORT - INTERIOR SIDE

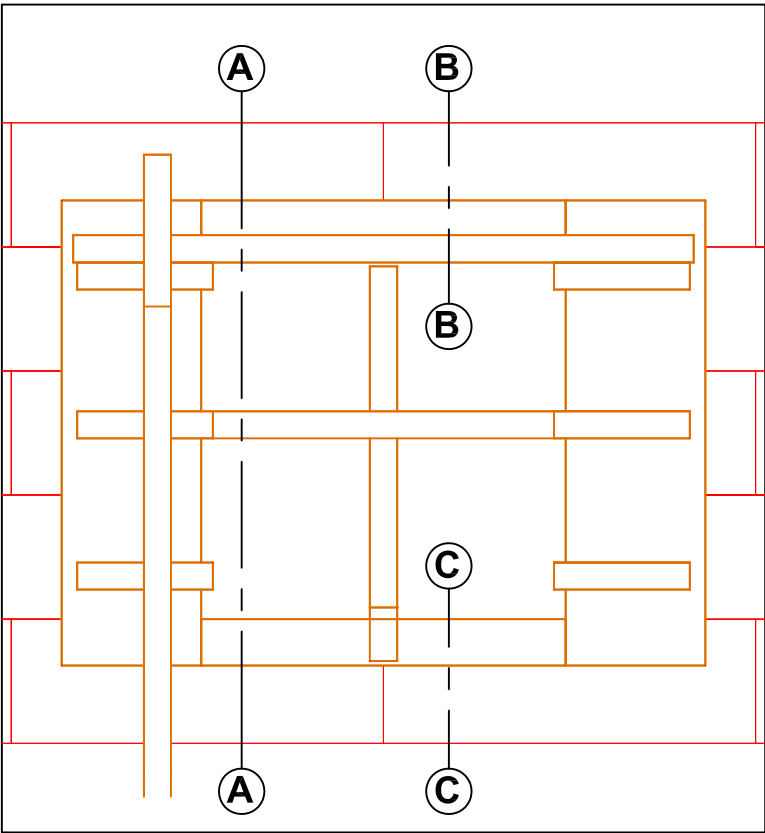

ELEVATION - EXTERIOR SIDE

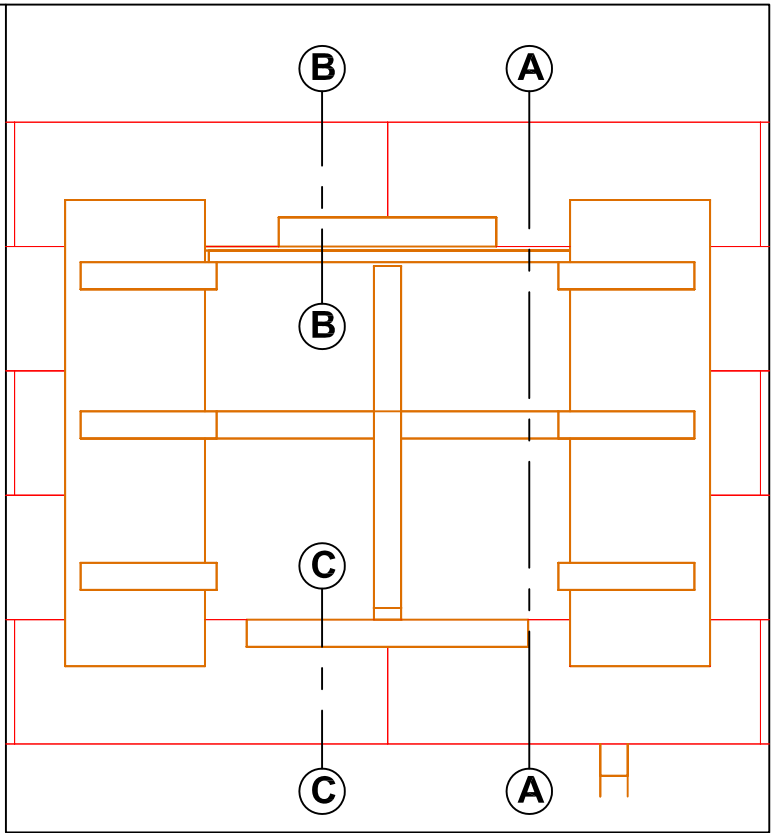

ELEVATION - INTERIOR SIDE

- NOTE:**
1. For 4" exposed concrete trim around opening on the interior face apply same form support and detail as shown for exterior face details.
 2. Unless otherwise shown, temporary form work material includes 2x4 and plysheets.

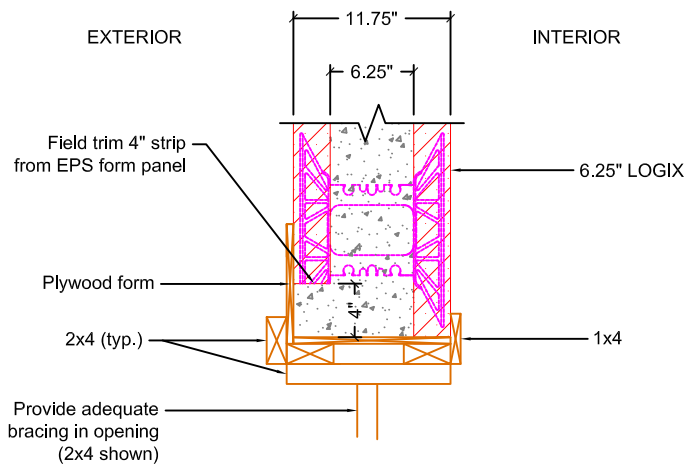

A - A
FORM SUPPORT ALONG
LINTEL

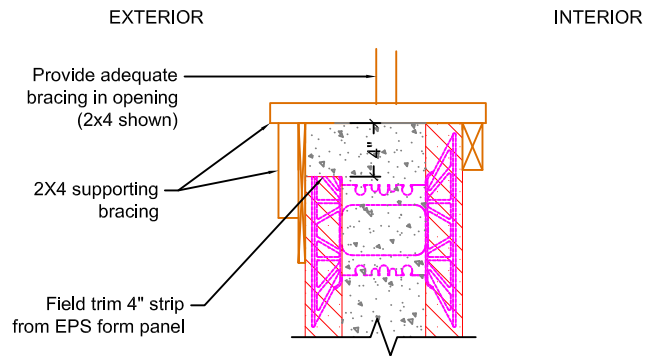

B - B
FORM SUPPORT ALONG
SILL

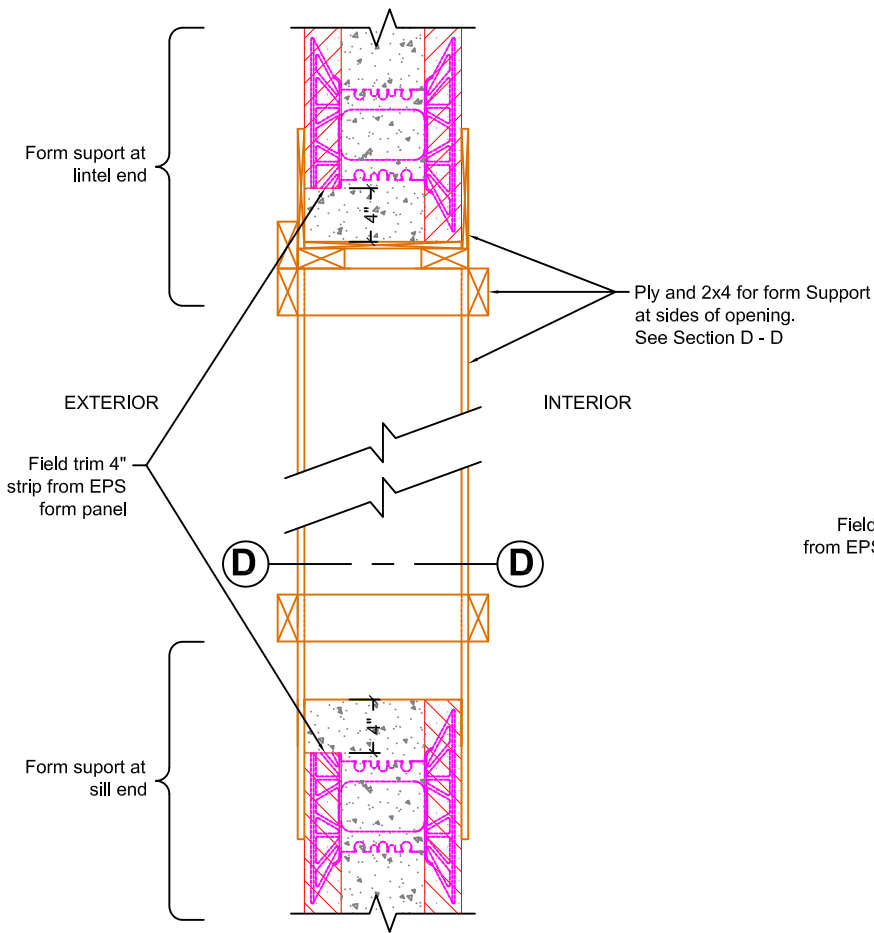

C - C
FORM SUPPORT AT
LINTEL AND SILL END

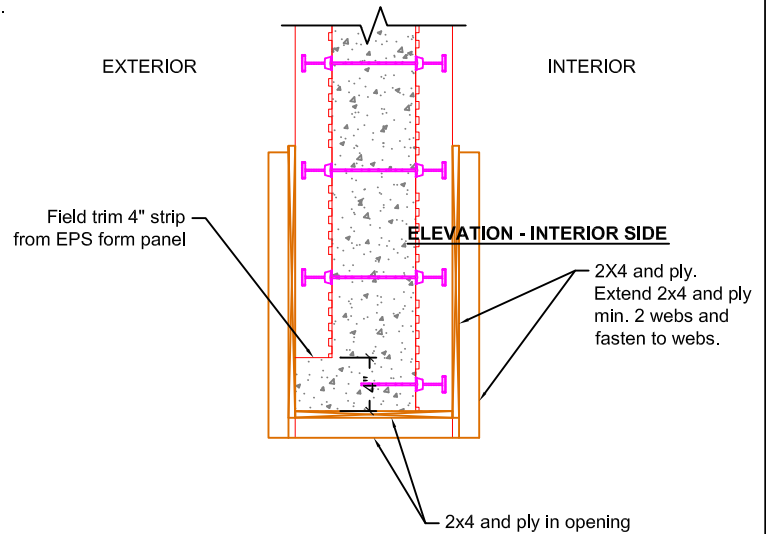

D - D
FORM SUPPORT AT SIDES
OF OPENING

NOTE:

1. For 4" exposed concrete trim around opening on the interior face apply same form support and detail as shown for exterior face details.
2. Unless otherwise shown, temporary form work material includes 2x4 and plysheets.